

1234 = mm.



VIP

TYPE

Q

	1010 ÷ 1100	1110 ÷ 1200	1210 ÷ 1300	1310 ÷ 1400	1410 ÷ 1500	1510 ÷ 1600	1610 ÷ 1700	1710 ÷ 1800	1810 ÷ 1900	1910 ÷ 2000	2010 ÷ 2100
		1100	1200	1300	1400	1500	1600	1700	1800	1900	2000
		1100	1200	1300	1400	1500	1600				

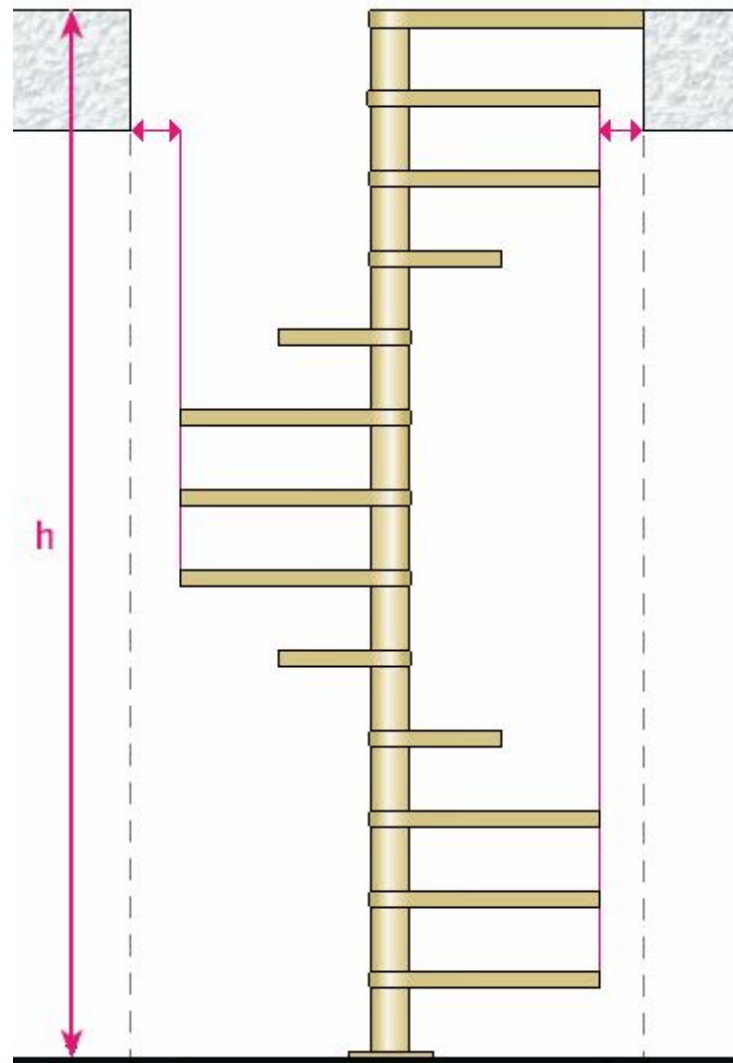

1234 = mm.

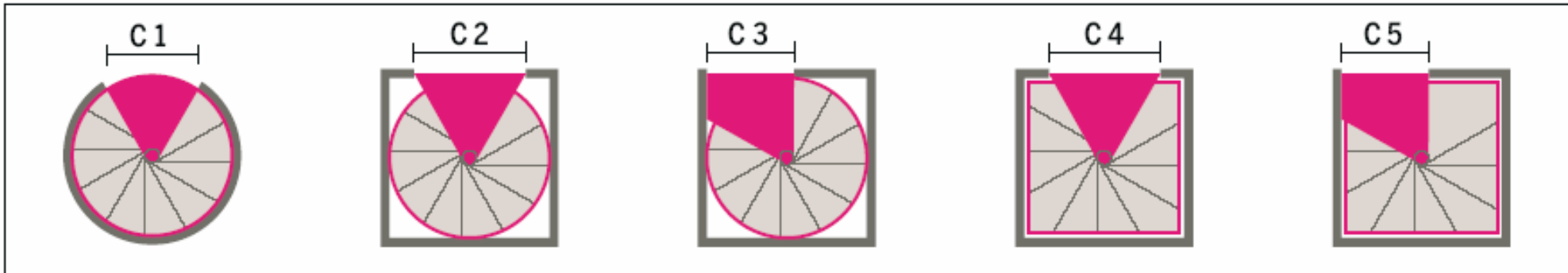

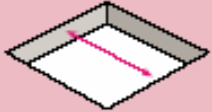
		1000	1100	1200	1300	1400	1500	1600	1700	1800	1900	2000	2100
 	C1	-	622	675	722	773	823	873	924	973	1023	1073	1123
	C2	-	729	787	846	904	962	1021	1080	1134	1193	1251	1090
	C3	-	601	649	696	743	791	838	886	956	1012	1040	1310
	C4	-	698	773	696	756	897	963					
	C5	-	601	648	696	743	791	838					

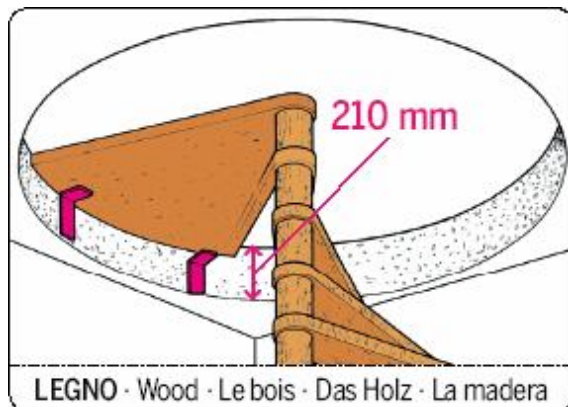

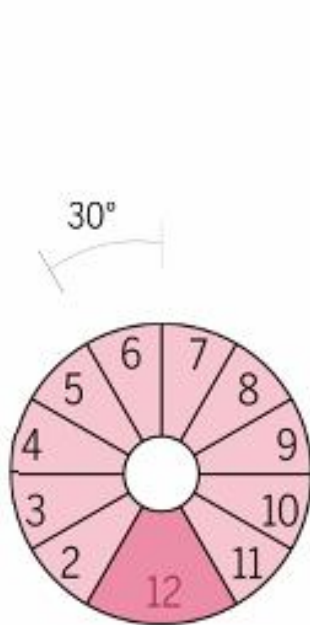

Ø 1000 / 1300

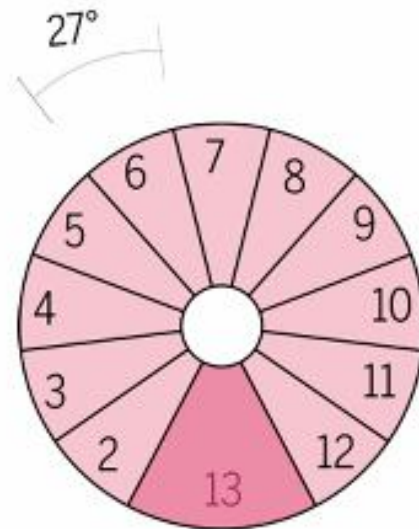

Ø 1400 / 1800

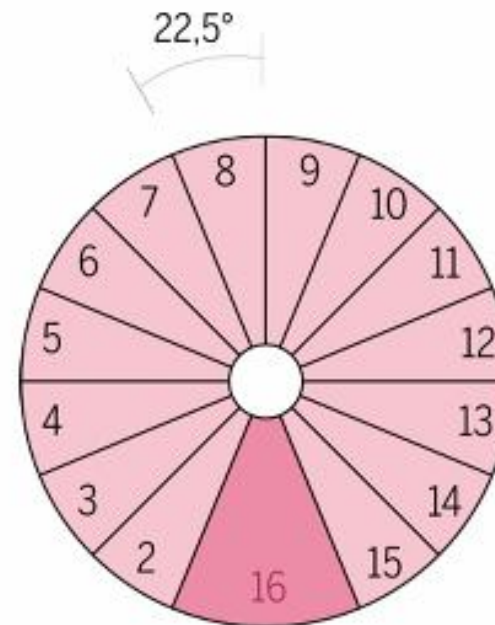

Ø 1900 / 2000

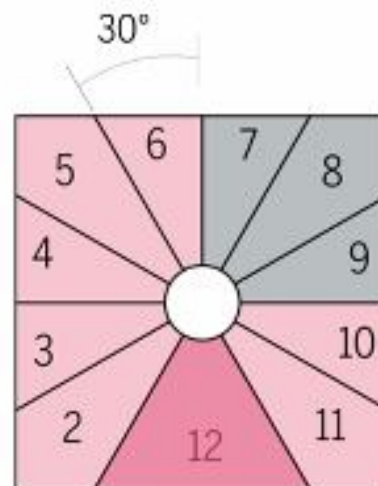

Ø 1000 / 1600

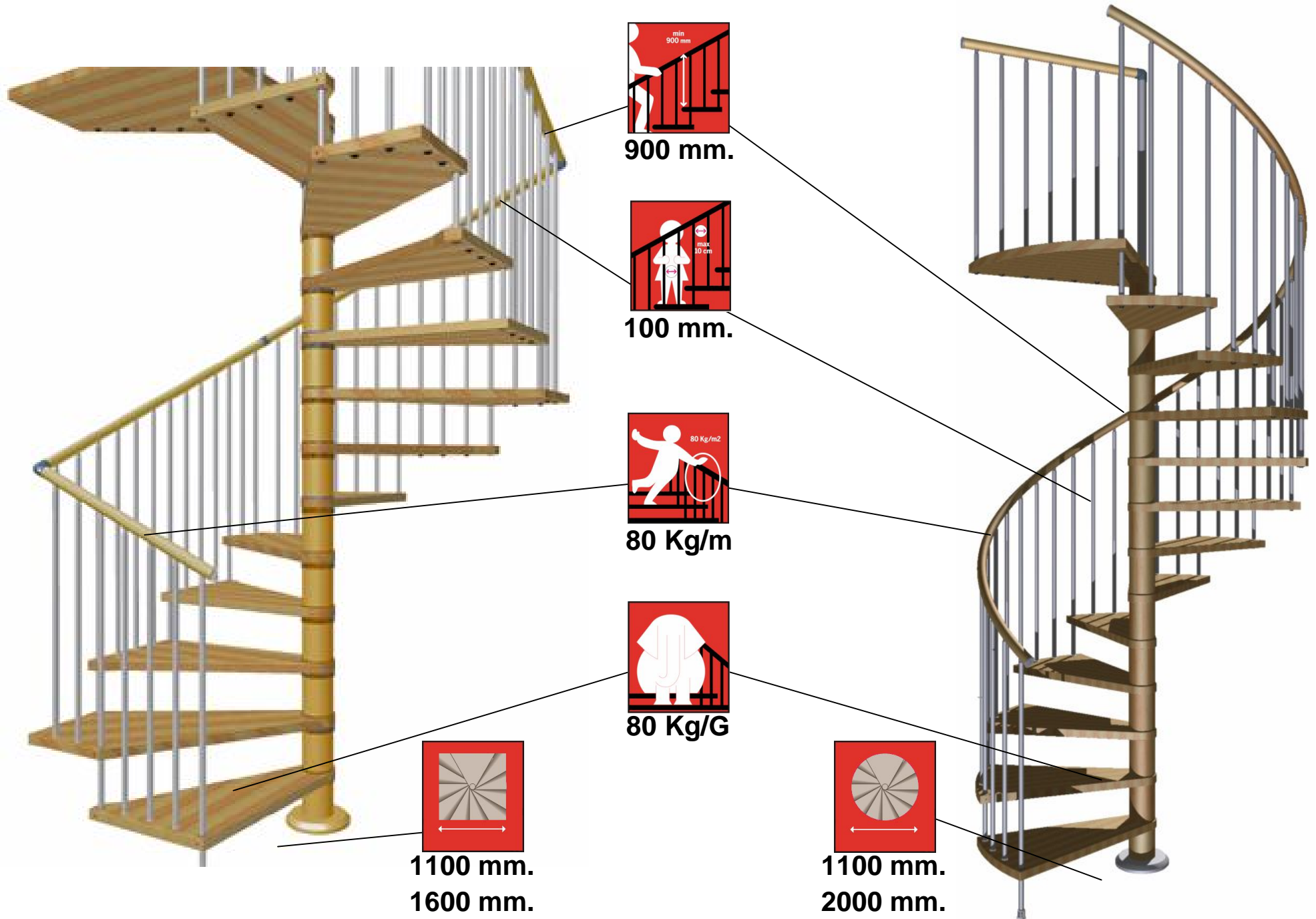

1234 = mm.

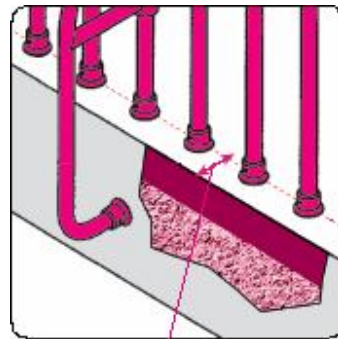
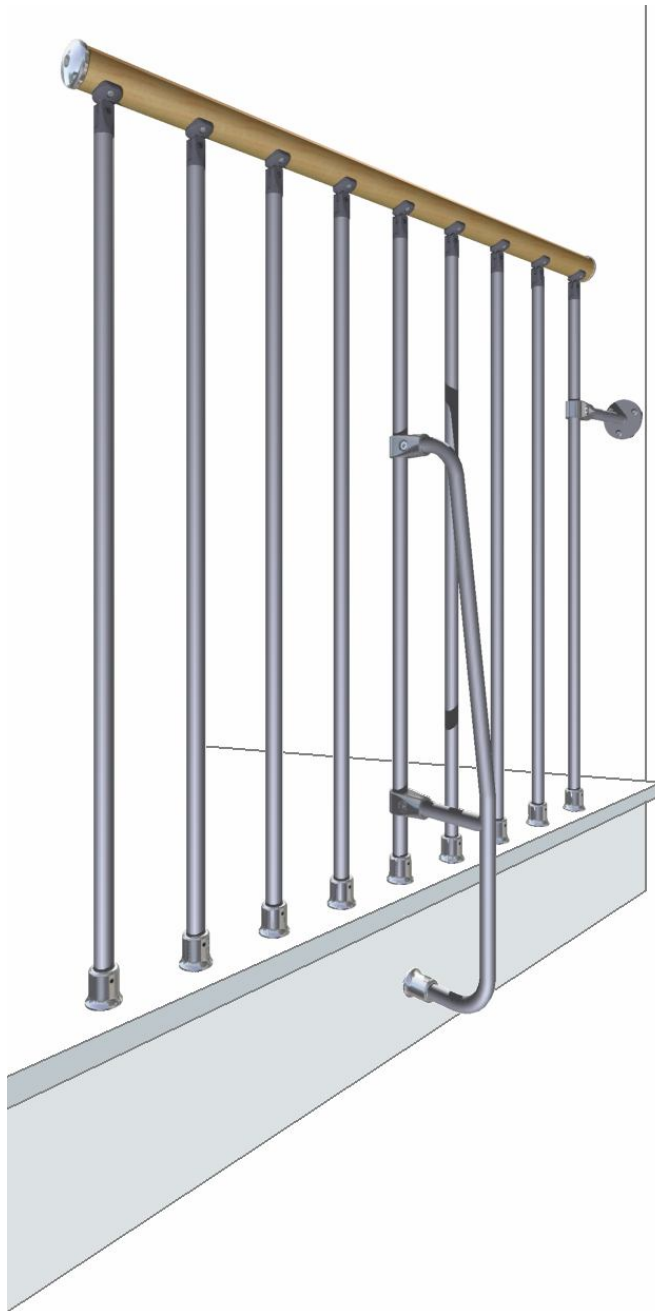

50 mm.

